

Haier

User Manual Dishwasher

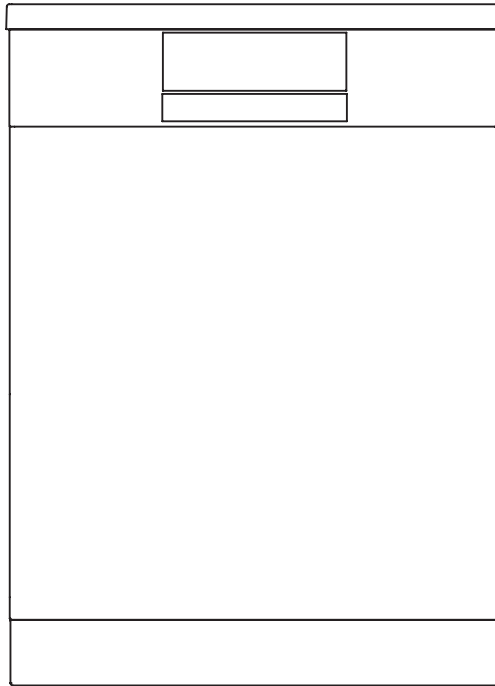

HDWI3G1 / HDWI4G2
HDWI5G2P / HDWI5G3 Models

Thank you for purchasing a Haier Product

Please read these instructions carefully before using this appliance. The instructions contain important information which will help you get the best out of the appliance and ensure safe and proper installation, use and maintenance.

Keep this manual in a convenient place so you can always refer to it for the safe and proper use of the appliance.

If you sell the appliance, give it away, or leave it behind when you move house, make sure you also pass this manual so that the new owner can become familiar with the appliance and safety warnings.

Legend



General information and tips



Warning – Important Safety information



Environmental information

Disposal



Help protect the environment and human health. Put the packaging in applicable containers to recycle it. Help to recycle waste of electrical and electronic appliances. Do not dispose appliances marked with this symbol with the household waste. Return the product to your local recycling facility or contact your municipal office.



WARNING!

Risk of injury or suffocation!

Disconnect the appliance from the mains supply. Cut off the mains cable and dispose of it. Remove the door catch to prevent children and pets to get closed in the appliance.

Content

Safety	3
Product Description	5
Control-Panel	6
Programmes	8
Before first Use	9
Daily Use	12
Care and Cleaning	22
Troubleshooting	24
Economic and Environmental Use	27
Installation	28
Technical Data	32
Customer Service	33
Standards Test	34

Safety

Intended Use

The appliance is designed for domestic use inside the house. It is not intended for commercial or industrial use. Do not use it for purposes other than that for which it was designed.

Changes or modifications to the device are not allowed. Unintended use may cause hazards and loss of warranty claims.

Standards and Directives

This product meets the requirements of all applicable EC directives with the corresponding harmonised standards, which provide for CE marking.

Before Switching on the Appliance for the First Time

Do...

- ▶ make sure all packaging is removed and is kept out of childrens reach.
- ▶ make sure that the electrical information on the rating plate agrees with the power supply. If it does not, contact an electrician.
- ▶ use a separate earthed socket for the power supply. The appliance must be earthed.
- ▶ make sure the plug is easy accessible.
- ▶ make sure only the delivered electric cable and hose set are used.
- ▶ hold the plug and not the electric cable when unplugging the power supply.
- ▶ make sure not to damage the electric cable and the plug. If damaged have it replaced by an electrician.
- ▶ make sure the hose joints and connections are firm and there is no leakage.

Do not...

- ✗ install or use the appliance where the temperature is below 5 °C.
- ✗ use multi-plug adapters and extension cables.
- ✗ let persons, children included, with reduced physical sensory, reduced mental functions or lack of experience and knowledge use the appliance if not supervised by a person responsible for their safety.
- ✗ put flammable products or items that are wet with flammable products in, near or on the appliance.

During Daily Use

Do...

- ▶ supervise children to prevent them playing with the appliance.
- ▶ put sharp pointed objects (e.g. knives) in a way that there is no danger of injury.

Do not...

- × open the door while a programme operates. The appliance can release hot steam.
- × keep the appliance door open without supervision to prevent tripping and falling.
- × let children or pets come close to the appliance when the door is open.
- × sit or place heavy items on the open door.
- × remove the dishes from the appliance until the programme is completed. There can still be detergent on the dishes.
- × drink the water in the appliance. The water may be contaminated with detergent residues.
- × cover any ventilation openings in the base by a carpet or similar object.
- × use water spray or steam to clean the appliance.
- × let the children make the cleaning and user maintenance without supervision.

Product Description

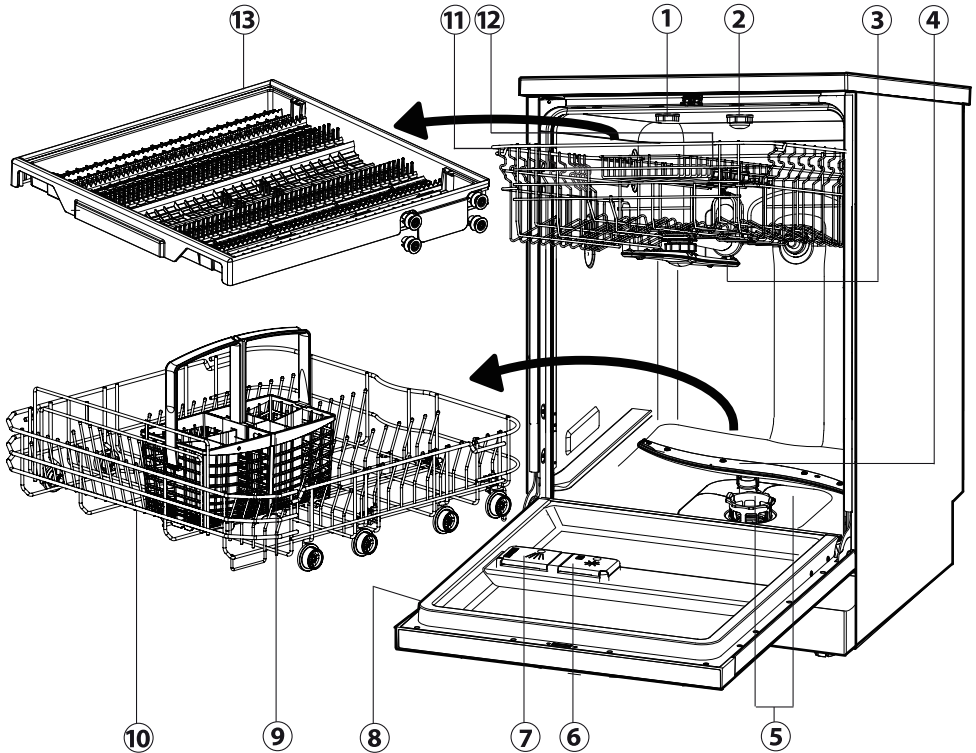

- | | |
|-----------------------------|------------------------------------|
| 1. Thermo dry ¹⁾ | 8. Rating label |
| 2. Top spray ²⁾ | 9. Cutlery basket ³⁾ |
| 3. Upper spray arm | 10. Lower basket |
| 4. Lower spray arm | 11. Upper basket |
| 5. Filters | 12. Knife rack |
| 6. Rinse aid dispenser | 13. The third basket ⁴⁾ |
| 7. Detergent dispenser | |

Accessories

Check the accessories and literature in accordance with this list:



water inlet hose⁵⁾



U-support



User manual

1) , 2) Applicable to models HDW14G2, HDW15G2P and HDW15G3 .

4) Applicable to models HDW15G2P and HDW15G3.

3) Applicable to models HDW13G1 and HDW14G2 .

5) Applicable to models HDW13G1, HDW14G2 and HDW15G2P.

Control Panel

HDWI3GI/HDWI4G2/HDWI5G2P :

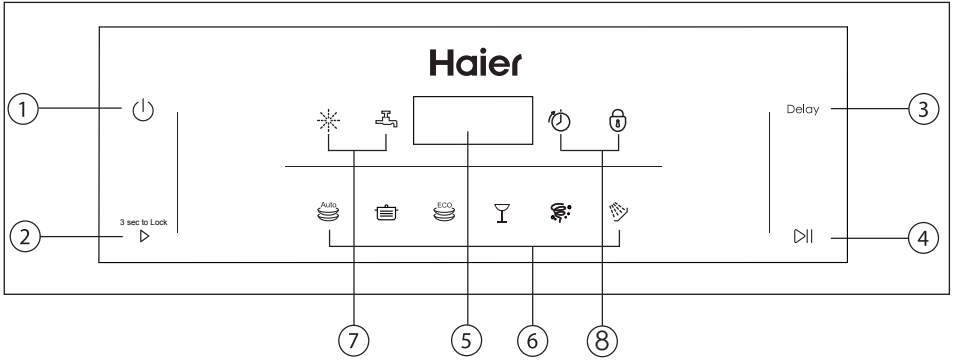

- | | |
|---|--|
| <ul style="list-style-type: none"> 1. ON / OFF button 2. PROGRAMME SELECT button 3. START DELAY button Delay 4. START / PAUSE button 5. Time & Info Display 6. Programme Indicators | <ul style="list-style-type: none"> 7. Deficit Indicators <ul style="list-style-type: none"> Rinse aid indicator Water tap indicator 8. Option Indication <ul style="list-style-type: none"> Delay start indicator Child Lock indicator |
|---|--|

HDWI5G3 :

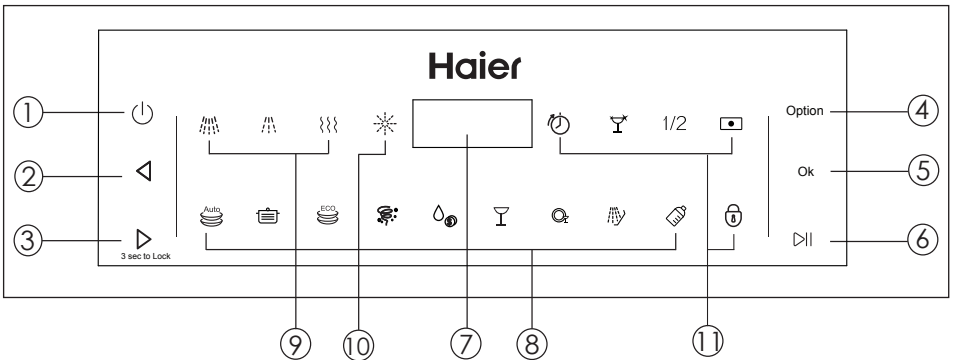

- | | |
|---|--|
| <ul style="list-style-type: none"> 1. ON / OFF button 2. PROGRAMME SELECT Left button 3. PROGRAMME SELECT Right button 4. Option SELECT button 5. OK button 6. START / PAUSE button | <ul style="list-style-type: none"> 7. Time & Info Display 8. Programme Indicators 9. Status Indication 10. Deficit Indication 11. Option Indication |
|---|--|

Control Panel

Time & Info display

During any selection the display shows by flashing related information like

- ▶ Programme cycle time
- ▶ Programme start delay time
- ▶ Error codes and service information

After start of an operation it displays without flashing:

- ▶ Remaining time in hours of a delayed programme starts, e.g. 24h
- ▶ Remaining programme cycle time in hours + minutes, e.g. 1:59

While running it may vary due to local conditions and daily working load.

Deficit Indicators



Rinse aid

If the indicator lights up: Rinse aid is empty!
This indicator is off while the programme operates.



Water tap

If the indicator lights up: The appliance does not fill with water.
Check section: "TROUBLESHOOTING"

Status Indicators



Wash

If the indicator lights up: the Dishwasher is washing.



Rinse

If the indicator lights up: the Dishwasher is rinse washing.



Dry

If the indicator lights up: the Dishwasher is drying.

Option Indication



Delay start

You can delay the start of a programme in 1 hour steps up to 24 hours. Check the according paragraph under "Daily use".



Child Lock

To active or cancel Child lock, press and hold ▶ until the Child lock indicator comes on



Extra shine

This option reduces spots on glassware and dinnerware. The option adds an extra intermediate rinse.

1/2

Half load







Use this option if you have only a few items to wash. This will save water, energy and time. If you use powder detergent use a little less detergent than for a full load.





Multitab

Activate this option only when you use the combi detergent tablets. This option decreases the flow of rinse aid and salt. Related indication. The programme duration can increase.

Programmes

Programme	Type of food residue	Type of load
 Auto 45–70°C ¹⁾	Light to heavy soil: Casseroles, sauces, potatoes, pasta, rice, roasted or fried food	Non-delicate: Dinnerware, cutlery, pots and pans
 Heavy 70°C	Heavy soil: Casseroles, sauces, potatoes, pasta, rice, roasted or fried food	Non-delicate: Dinnerware, cutlery, pots and pans
 ECO 50°C	Normal soil: Soups, eggs, sauces, potatoes, pasta, rice, roasted or fried food	Non-delicate: Dinnerware cutlery, glassware
 Glass-Auto	Light soil: Coffee, cake, milk, cold drinks, salad, sausages	Delicate: Glassware, dinnerware, cutlery
 Fast 30min ²⁾	Fresh soil: Coffee, cake, milk, cold drinks, salad, sausages	Non-delicate: Dinnerware, cutlery, glassware
 Rinse ³⁾	Dishes to be stored for a few days before washing	All: Dinnerware, cutlery, glassware, pots and pans

On some models :

 Saving	Light or fresh soil: Soups, eggs, sauces, potatoes, pasta, rice, roasted or fried food	Non-delicate: Dinnerware, cutlery
 Mix 90min	Mixed soil: Coffee, cake, milk, cold drinks, salad, sausages, Casseroles, sauces, potatoes, pasta, rice, roasted or fried food	Non-delicate: Dinnerware, cutlery, glassware pots and pans
 Hygiene	Hygiene soil: Casseroles, sauces, potatoes, pasta, rice, roasted or fried food	Non-delicate: Dinnerware cutlery, pots and pans

- 1) The appliance senses the type of soil and the quantity of items in the baskets. It automatically adjusts the temperature and quantity of water, energy consumption and programme duration.
- 2) With this programme you can wash a load with fresh soil. It gives good washing results in a short time.
- 3) Use this programme to quickly rinse the dishes. This prevents the remaining food to bond on the dishes and bad odours to come out from the appliance. Do not use detergent with this programme!

Before first Use

First Steps

Remove all packaging materials, keep them out of childrens reach and dispose them in an environmentally friendly manner. There could be water residue inside the appliance due to quality checks in the factory.

Perform the following steps:

1. Install the appliance.
 - ▶ Refer to section INSTALLATION.
2. Only for use of Multitabs: Adjust the rinse aid setting.
 - ▶ Refer to section DIFFERENT SETTINGS FOR RINSE AID.
3. Fill the rinse aid dispenser.
 - ▶ Refer to section HOW TO FILL THE RINSE AID DISPENSER.
4. Open the water tap.
5. Start any wash programme (apart from 20 minutes programme) with detergent but no load to remove possible manufacturing residues.

Activate / De-Activate the Buzzer

An acoustic signal informs about the end of a programme. This signal can be switched off.

Refer to section HOW TO ADJUST SETTINGS and select the *b*-setting:

- ▶ If the display shows *b 0* the signal is switched off.
- ▶ If the display shows *b 1* the signal is switched on.

Different Settings for Rinse Aid

Rinse aid is added during the last rinsing phase to dry the dishes without streaks and stains.

Detergent (e.g. powder, tabs, ...)

- ▶ requires separate rinse aid:
Factory default setting: $d5$. No settings are necessary.
The rinse aid is added from the rinse aid dispenser only.

Detergent with multifunction (e.g. Multitabs)

- ▶ combine detergent and rinse aid:
The rinse aid setting should be adjust to $d2$. Please use the setting instructions in section HOW TO ADJUST SETTINGS and select the d -setting.
The rinse aid is added from the rinse aid dispenser in addition to the multitabs rinse aid.

Setting $d1$ cuts off the rinse aid dosage and the rinse aid indication.
The higher the value for d the higher the dosage.

Usually the recommended setting performs well. In case of streaks, stains, shimmer etc.; refer to section TROUBLESHOOTING.

How to fill the Rinse Aid Dispenser



CAUTION!

Only use rinse aid for dishwashers.
Other product can cause damage to the appliance!

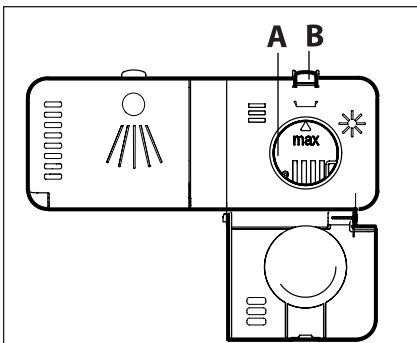

1. Press the release button (**B**) to open the lid.
2. Fill the tank (**A**) up to the ,max' mark.
3. Remove any spilled rinse aid with an absorbent cloth. Overdosed or spilled rinse aid may cause problems creating foam
4. Close the lid. Make sure that the release button locks into position.

Before first Use

How to Adjust Settings

To adjust the Rinse Aid level

1. The appliance is switched off.
2. Press and hold “**U** and **Delay**” about 3 seconds until (for HDW15G3, Press and hold “**U** and **Option**”):
 - ▶ The display shows the current Rinse Aid setting (the default is *d5*).



3. Press **U** (for HDW15G3, Press **OK**) to change the Rinse Aid setting in steps between *d1* (minimum dispense) and *d7* (maximum dispense).
4. To exit the Rinse Aid menu, press and hold 1 second **U**.

Activate / De-Activate the Buzzer



1. The appliance is switched off.
2. Press and hold **U** and **Delay** about 3 seconds until (for HDW15G3, Press and hold “**U** and **Option**”):
 - ▶ The display shows the current Rinse Aid setting.
3. Press **Delay** (for HDW15G3, press **Option**) to scroll to the buzzer menu.
4. The display will show *b0* (buzzer off) or *b1* (buzzer on).
5. Press **U** (for HDW15G3, press **OK**) to toggle between *b0* (buzzer off) or *b1* (buzzer on).
6. To exit, press and hold 1 second **U**.

Child lock

This feature disables all the buttons on the dishwasher. If any other buttons are pressed while Child lock is activated, the the Child lock indicator will flash for a few seconds.

1. To activate Child lock, press and hold **▶** that Child lock has been activated.
2. The display will remain on (if no programme has been started it will continue to flash while the control panel is locked).
3. To cancel Child lock, press and hold **▶** that Child lock has been cancelled.

Please note that not all sales models comes with identical features and options. So pictures of that chapter are sometimes different to your dishwasher model. Explanations try only to point out basic model variants.

1. Load the baskets.
2. Open the water tap.
3. Press the ON/OFF button  to activate the appliance.
 - ▶ If the rinse aid indicator is on, fill the rinse aid dispenser and reset the rinse aid indicator; refer to section HOW TO RESET THE RINSE AID IDNICATOR.
4. Add the detergent; refer to section DETERGENT.
5. Close the door.
6. Set the programme according to the type of load and how dirty the dishes, cups and cutlery are.
7. Maybe select a start delay time.
8. Press the START / PAUSE button  to start the programme.
9. After programme end close the water tap.
10. After programme end the appliance change to auto off. Unload the baskets.

How to Reset Rinse Aid Indicator

The appliance is switched on.

The rinse aid indicator is on:

1. Always completely fill the rinse aid before starting the next wash cycle.
2. Press and hold the START/PAUSE button  until the indicators light up. The programme starts.

Daily Use

Load the Baskets

i With delicate glasses and porcelain make sure they are labelled dishwasher-proof.

- ✗ Do not put in the appliance items made of wood, horn, aluminium, pewter and copper.
- ✗ Do not put in the appliance items that can absorb water (sponges, household cloths).
 - ▶ Only use the appliance to wash items that are dishwasher-safe.
 - ▶ Remove remaining food from the items.
 - ▶ Soften burned food on the items before washing.
 - ▶ Put hollow items (cups, glasses and pans) with the opening down.
 - ▶ Put items with deep hollows in a slanted position.
 - ▶ Mix spoons with other cutlery to prevent them to bond together.
 - ▶ Make sure that cutlery and dishes do not bond together and there is a gap between each item.
 - ▶ Make sure that glasses do not touch other glasses.
 - ▶ Put small items in the cutlery basket.
 - ▶ Put light items in the upper basket. Make sure that the items do not move.
 - ▶ Make sure that the spray arms can move freely before you start a programme.

i If jingling noises are heard during a programme run: Check that the dishes and glassware have a firm position.

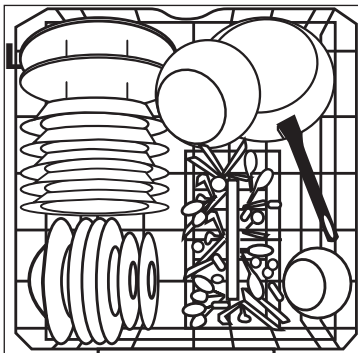

Place heavily soiled items (like pots and pans or dinner plates) in the bottom basket. The more powerful spray jet provides a better dishwashing result.

HDWI4G2 , HDWI5G2P and HDWI5G3:

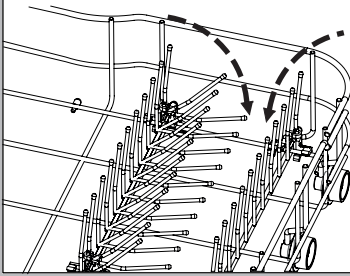

The lower basket has folding spikes. Fold down these spikes to improve arrangement of pots, pans and bowls.

Cutlery Basket

HDWI3GI and HDWI4G2:

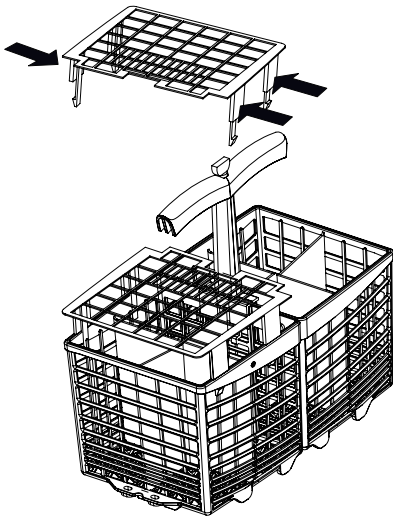

- ▶ Mix spoons with other cutlery to prevent them to bond together.
- ▶ Use the grid element in order to separate the cutlery.
- ▶ Place cutlery with the handles down for better washing results.
- ▶ If long items may block the spray arms find a horizontal positioning in the upper basket.

CAUTION!



Put sharp and pointed items with the blade pointing downward to keep them out of harms way.

Daily Use

Upper Basket and utensil tray

HDW13G1:

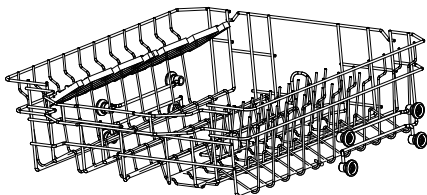

HDW14G2:

Utensil tray

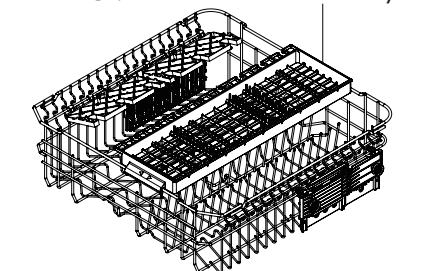

Utensil tray

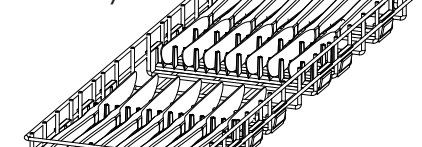

HDW15G2P and HDW15G3:

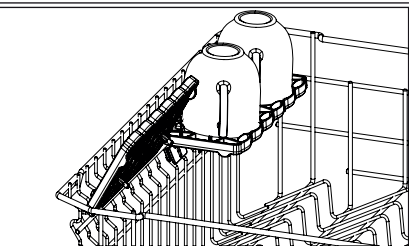
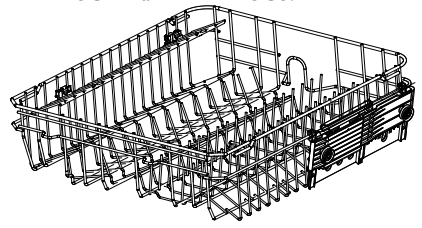

- ▶ The upper basket is designed to hold items like glasses, cups, saucers, plates, small bowls and shallow pans.
- ▶ Use the utensil tray to securely hold long or sharp items like knives, chopsticks, or ladles. Ensure that knife blades are facing down.
- ▶ Slide or remove the utensil tray if you need the space for other items below.
- ▶ You can adjust the height of the upper basket to create more space for tall items in the lower basket.
- ▶ For best washing results place the table knives in the knife rack.

Place small items on the foldable cup holder.



CAUTION!

Place sharp and pointed items with the blade pointing downward into the knife rack, to keep them out of harms way.

Model with lever for easy height adjustment of the upper basket.

HDWI3GI :

To create more space in the upper or lower basket the height of the upper basket can be adjusted.



CAUTION!

Only adjust the height if the basket is empty (weight).

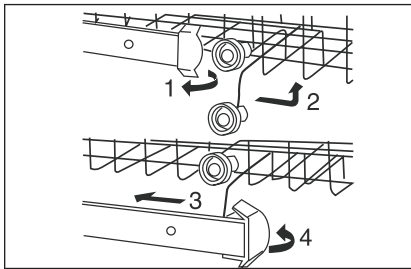

1. Open the locks of the two guide rails beside the basket.
2. Hold the basket on both sides and take it out.
3. Lift or lower the basket by inserting the appropriate roll set into the guide rails.
4. Close the locks of the two guide rails beside the basket.

HDWI4G2 / HDWI5G2P / HDWI5G3 :

Lift the basket

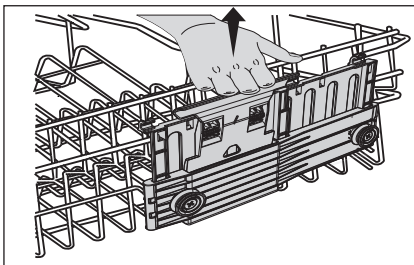

1. Pull out the upper basket.
2. Hold the basket on both sides on the edge above the lever.
3. Lift the basket till you hear a click.
4. Check the horizontal position and safe lock of the basket.

Lower the basket

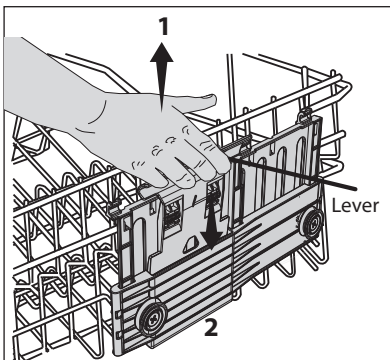

1. Press the lever on both sides to lower the basket.
2. Check the horizontal position and safe lock of the basket.

Daily Use

The third Basket

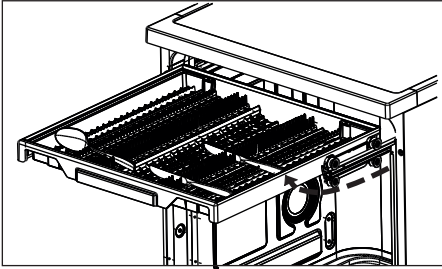

The third basket can be pulled out, it is easy to put down and take out the cutlery.

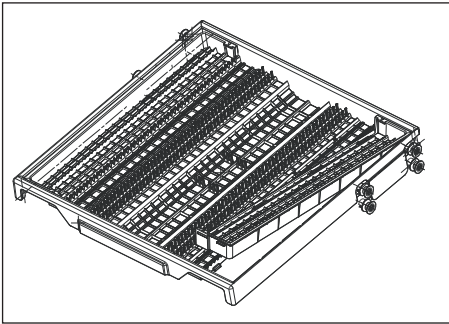

Depending on the model, you can take out the third basket.

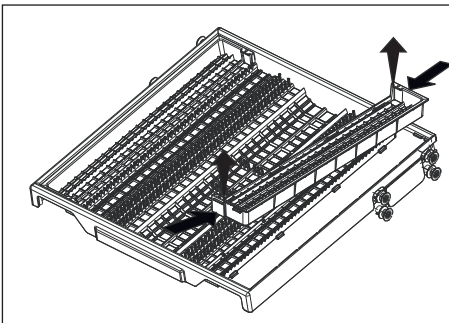

Depending on the model, you can take out the left and right side shelves to provide more room for taller goblet.

Detergent



Please use only a dedicated dishwasher detergent and follow the related instructions and dosage on its package.

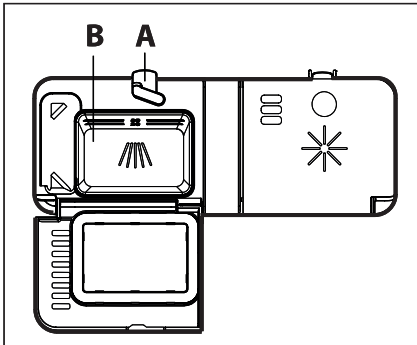

1. If the lid is closed press the release button **(A)** to open the lid.
2. Put any detergent into compartment **(B)**.
3. If the programme has a pre-wash phase, put a small quantity of detergent on the inner part of the appliance door. Refer to section PROGRAMMES.
4. Close the lid. Make sure that the release button locks into position.

Multitabs

These combi detergent tablets could include too different agents for water softening, rinse aid and other functions. The softener and rinse aid setting must be adjusted acc. to section BEFORE FIRST USE.

Usually the default setting performs well. If there are streaks, stains, shimmer etc.; refer to section TROUBLESHOOTING and BEFORE FIRST USE.





Detergent tablets do not fully dissolve with short programmes. That may cause bad washing results and detergent residues.

If detergent without multifunction should be used again:

1. Save 3 to 5 tablets
2. Adjust the softener and rinse aid setting according to section BEFORE FIRST USE.
3. Use combi detergent tablets for the next 3 to 5 wash cycles.

Daily Use

Start a Programme



1. Close the door.
2. Open the water tap.
3. Press the ON/OFF button .
4. Press sequentially the PROGRAMME SELECT button  until the required programme indicator lights up.
Additionally the display flashes the programme run-time.
5. If desired select a start time for a delay start. Refer to section START A PROGRAMME WITH DELAY.
6. Press the START/PAUSE button  to activate the programme or the delay start.
The programme starts. The display acts now as countdown of the remaining run-time.



The appliance remembers the last programme you used. The next time the appliance will switch on, the appliance pre-selects the programme last used.

Interrupt a Running Programme



To interrupt a programme run:

- ▶ Press the START/PAUSE button . In the display  is flashing.
and/or
- ▶ Open the door. The displayed cycle time is flashing.

Press the START/PAUSE button  and/or close the door to continue the programme from the point of interruption. Longer breaks may cause bad cleaning results.

Activate / Deactivate options

On some models, the combination of all options is possible with all programmes. You can set one option or combine all options.

1. Switch on the appliance.
2. Select a programme.
The display shows the duration of the programme.
3. Press the option button .
The display switches off.
The first indicator of the options flashes.
4. Press the option button  again and again until the indicator of the required option flashes.

5. Confirm with the button **OK**.
OFF (or ON) flashes in the display.
6. Press the option button to select ON (or OFF).
7. Confirm with the **OK** button.
The option is activated (deactivated).
8. Repeat step 3 to 7 to activate more options.
9. Press the button **OK** to start the programme.

Start a Programme with Delay

Set a start time by the following procedure in order to delay a programme start:

1. Set a programme.
2. Press sequentially or hold the **START DELAY** button **Delay** until the display flashes the required delay time (from 1 to 24hours).
For HDW15G3 model:
press and hold the button **Option** until the display flashes, then press the button **OK**, the display shows $\square h$. press Left **PROGRAMME SELECT** button \blacktriangleleft or Right **PROGRAMME SELECT** button \blacktriangleright until the display flashes the set time, then press **OK** button.
3. Press the **START/PAUSE** button $\blacktriangleright||$.
 - ▶ The display shows the countdown of the start delay. The countdown decreases with steps of 1 hour.
 - ▶ When the countdown is completed, the programme starts.

Cancel a Delayed Start

Press sequentially the **START DELAY** button **Delay** until the display shows $\square h$ for a short time. Afterwards the display flashes with the duration time for the set programme.

For HDW15G3 model: press the **START/PAUSE** button, press **Option** button, then press Left **PROGRAMME SELECT** button \blacktriangleleft or Right **PROGRAMME SELECT** button \blacktriangleleft until the display shows $\square h$ for a short time, then press **OK** button. Afterwards the display flashes with the duration time for the set programme.

The selected programme starts after a few seconds.

Daily Use

Cancel Start Delay / Programme

1. Press the ON/OFF button  for about 1 second.
 - ▶ The start delay is cancelled.
 - ▶ The programme is aborted.
 - ▶ The appliance is switched off.
2. Start a new programme and a delayed start if desired.



CAUTION!

If a programme will be aborted in the process of washing dishes, the residue of detergent remains on the dishes. These can cause damage to health! Make sure to rinse off the detergent residues completely before using these dishes again.



Make sure that there is detergent in the detergent dispenser before start a new programme.

End of Programme

When the programme is completed, the display shows  and an acoustic signal is heard (if it is not switched off). The display switches off.

1. Press  to switch off the appliance or the appliance switches into standby mode automatically after 2 minutes.
2. Open the door.



CAUTION!

If the door will be opened immediately after the end of programme, hot steam can escape. Danger of scalding! Open the door carefully!

3. Close the water tap.
4. Remove dishes:
 - ▶ Open the door slightly and leave it ajar (about 100 mm) to help the drying process.
 - ▶ Let the dishes become cold before removing them from the appliance. Hot dishes damage more easily.
 - ▶ First remove the items from the lower basket, then from the upper basket.



There can be water on the sides and on the door of the appliance. Stainless steel becomes cool more quickly than the dishes.

Standby Mode

The switched on appliance will go into standby mode if it is not activated within 2 minutes before starting a programme, or at the end of a programme. This save energy. The display switches off. To interrupt the standby mode push one button.

Care and Cleaning

Inspect and clean your appliance at regular intervals. Basically any detergent and food residues may cause diverse problems. But especially dirty filters, clogged or blocked spray arms significantly decrease the washing results.

Care and Cleaning the Filters

There are three filters (A1, A2, B) to be checked and cleaned.

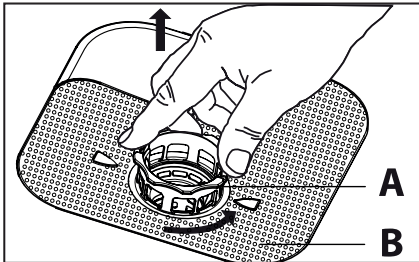

1. Turn the filter **A** anticlockwise and remove it.

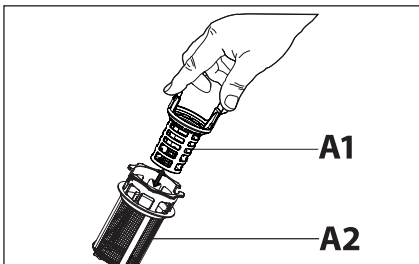

2. To disassemble the filter **A** press the latches and unplug **A1** from **A2**.

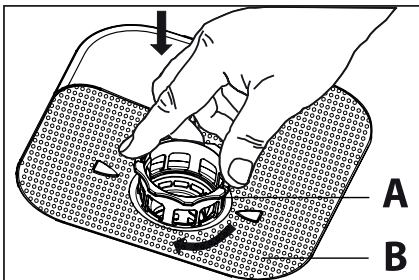

3. Remove the filter **B**.
4. Clean the filters with water.
5. Put the filter **B** to its initial position.
6. Assemble the filter **A** and put it into position in filter **B**. Turn it clockwise until it locks.



An incorrect assembly or position of the filters will cause bad washing results and possibly serious damage to the appliance.

If any filter is removed make sure that no solid object of any size is left beyond these filters!

Care and Cleaning

Care and Cleaning of the Spray Arms

Spray arms should be regularly inspected for dirt. If needed the spray arms could be removed.

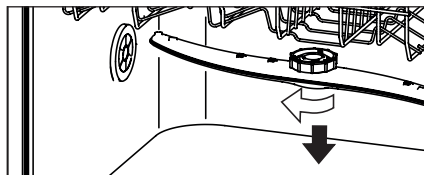

Upper spray arm

1. Turn bayonet socket to the left to remove spray arm.
2. Remove remaining parts of food remnants with a thin pointed object.
3. Flush with water and check all the holes are clear.
4. Turn bayonet socket clockwise to fasten spray arm.

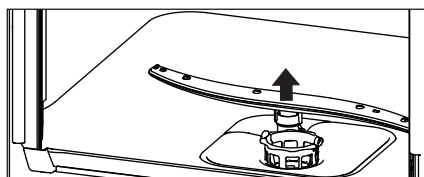

Lower spray arm

1. Pull at the center to remove spray arm.
2. Remove remaining parts of food remnants with a thin pointed object.
3. Flush with water and check all the holes are clear.
4. Place spray arm at the center with a light push.

External Cleaning



CAUTION!

Never clean the appliance with a steam cleaner.
Never use bleach or other chlorinated detergents.

- ▶ Clean the appliance with a damp soft cloth.
- ▶ Only use neutral detergents. Do not use abrasive products, abrasive cleaning pads or solvents.
- ▶ Clean the door seal with a damp soft cloth.

Troubleshooting

Many occurring problems could be solved by yourself without specific expertise. In case of a problem please check all shown possibilities and follow below instructions before you contact an after sales service



CAUTION!

- ▶ Before maintenance, deactivate the appliance and disconnect the mains plug from the mains socket.
- ▶ Electrical equipment should be serviced only by qualified electrical experts, because improper repairs can cause considerable consequential damages.

The appliance does not start or it stops during operation

Problem	Possible cause	Possible solution
The programme does not start.	Appliance door is open.	Close the appliance door.
	Delay start is set.	Refer to displayed time.
	Mains plug is not connected in the mains socket.	Connect the mains plug.
	Fuse in the house circuit is damaged.	Replace the fuse.
Rinse Aid Indicator  is lighted.	Rinse aid dispenser is empty.	Refill Rinse aid till full.
	Refill of rinse aid was not confirmed.	Press and hold the START/PAUSE button for 1 sec after each refill.

Troubleshooting

Error codes on the display

Problem	Possible cause	Possible solution
Acoustic alarm, display shows ALARMCODE <i>E10</i> The appliance does not fill with water.	Water tap is closed.	<ul style="list-style-type: none"> Open the water tap. Note: Whenever „Error 10“ is solved switch off the appliance and restart the programm.
	Water inlet hose has a kink or a bend.	Make sure that the position of the hose is correct.
	In case of aqua-stop system: water protection is triggered; the marker (C) is red.	The hose must be replaced.
	Filter in the water inlet hose is clogged.	Clean the filter at the inlet hose connections at tap and the rear of the appliance.
	Water inlet is clogged.	Check water flow from tap.
	Water pressure is too low.	Contact your local water authority.
Acoustic alarm, display shows ALARMCODE <i>E20</i> The appliance does not drain sufficiently	Filters are clogged	<ul style="list-style-type: none"> Scoop out as much water as possible. Clean filters. Continue programme by pressing the START/PAUSE button.
	the drainage is blocked	<ul style="list-style-type: none"> Scoop out as much water as possible. Make sure that drain water-connection and piping is correct and not blocked. Continue programme by pressing the START/PAUSE button. If the fault persists, contact customer care.
Acoustic alarm, display shows ALARMCODE <i>E30</i> Leak: The drain pump runs permanently!	Anti-flood device is on: <ul style="list-style-type: none"> There are water leakages in the appliance. The water inlet valve is open and blocked. The drainage is blocked. 	<ol style="list-style-type: none"> Close the water tap. Disconnect appliance from power supply. Contact Service.

All other Alarmcodes:

- Note Alarmcode
- Contact Service ; refer to CUSTOMER SERVICE

Troubleshooting

Washing Results are not satisfactory

Problem	Possible cause	Possible solution
The dishes are not clean.	Filters are clogged.	Clean the filters.
	Filters are not correctly assembled and installed.	Make sure that the filters are correctly assembled and installed.
	Spray arms are clogged.	Remove remaining food remnants with a thin pointed object.
	Programme was not applicable for the type of load and food remnants.	Make sure that the programme is applicable for the type of load and food remnants.
	Incorrect position of the items in the baskets. Water could not wash all items.	Make sure that the position of the items in the baskets is correct and that the water can easily wash all items.
	Spray arms could not turn freely.	Make sure that the position of the items in the baskets is correct and does not cause the blockage of the spray arms.
	No detergent or insufficient quantity of detergent in the detergent dispenser.	Make sure that you add the correct quantity detergent in the dispenser before you start a programme
	The wash cycle was interrupted by a long break.	Do not open the door or cut power supply during the wash cycle.
Whitish streaks, stains or bluish layers on glasses and dishes.	Released quantity of rinse aid is too much.	Decrease the released quantity of rinse aid. Refer to section DIFFERENT SETTINGS FOR RINSE AID.
	Quantity of detergent was too much.	Make sure that you add the correct quantity of detergent in the dispenser before you start a programme.
	Combi detergent tablets used with a short programme might not fully dissolve.	Select a longer programme when using combi detergent tablets.

Troubleshooting

Problem	Possible cause	Possible solution
Dry water drop stains on glasses and dishes.	Rinse aid dosage is too low..	Increase the released quantity of rinse aid. Refer to section DIFFERENT SETTINGS FOR RINSE AID.
	Quality of rinse aid or Multitab.	Cleaning product too old; change the product.
The dishes are wet.	<ul style="list-style-type: none">• Programme had no drying phase.• Programme had a low temperature drying phase.	Open the door slightly and leave it ajar (about 100 mm) to help the drying process.
The dishes are wet and matt.	Rinse aid dispenser is empty.	Refill rinse aid into the dispenser and reset the rinse aid indicator.
	Quality of rinse aid or Multitab.	Cleaning product too old; change the product.



Economic and Environmental Use

- ▶ It is not recommended to pre-rinse the dishes under running water.
- ▶ Select the washing programmes by type and degree of contamination of the dishes.
- ▶ Select the economy mode programme ECO for normal soiled items.
- ▶ The most economically use you will have with full loading.
- ▶ Only use the manufacturers recommended detergent or rinse aid dosages.



WARNING!

Any installation may be carried out only by a qualified technician; refer to section SAFETY.

Free Standing Installation

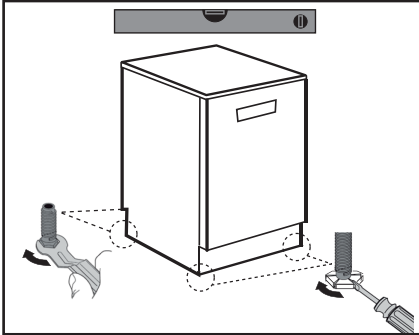

1. Install the appliance on solid ground. Adjust accurately all feet to get a firm, horizontal position.



INFORMATION!

Only with a correct level the appliance door closes and seals correctly.

Installation under Worktop

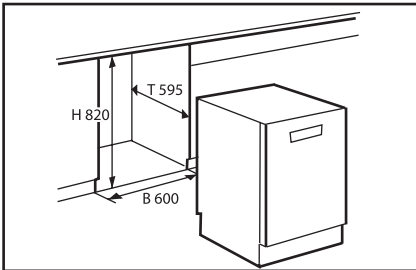

1. The dimensions of the recess should at least agree with the dimensions in the figure.
2. Put the appliance adjacent to the slot. Make sure that all connections (water; drain water; power) are neatly positioned and connected.

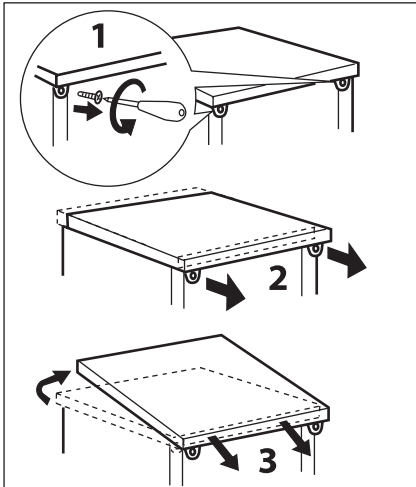

3. **Optional:** Remove the worktop of the appliance.
4. Adjust accurately all feet to get a firm level position.
5. Install the appliance carefully into the recess.



WARNING!

If used as free standing appliance again, the worktop must be remounted.

Installation

Fresh Water Connection

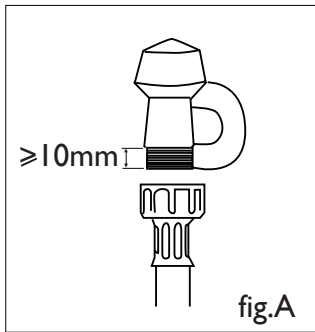

IMPORTANT!

- ▶ The appliance should be connected to the water main using the new water inlet hose supplied. Old hoses should not be used.
- ▶ Do not shorten the inlet hose.

1. Take note of water connection requirements.
 - ▶ The dishwasher has a single valve water connection.
 - ▶ We recommend a cold water connection for best performance and energy efficiency.
 - ▶ The incoming water temperature should not exceed 25°C.
2. Take note of the permitted water pressure extremes.
 - ▶ Lowest: 0.3 bar = 3 N/cm² = 30kPa
 - ▶ Where pressure is below 1 bar, contact a qualified plumber.
 - ▶ Highest: 10 bar = 100 N/cm² = 1MPa
 - ▶ Where pressure is above 10 bar, a pressure reduction valve must be installed. Contact a qualified plumber.
3. Connect the water inlet hose to an accessible water tap with a 3/4" BSP connector (see fig.A). Ensure that there is no kink in the inlet hose that could restrict the flow of water. A 90° bend requires a minimum height of 200 mm for a kink-free curve.
 - ▶ Ensure incoming water is clear. If the water pipes have not been used for a long period of time, let the water run to make sure it is clear with no impurities. Not doing so may result in the water inlet hose getting blocked and damaging the appliance.
 - ▶ If required, use a filter insert to filter out deposits from the piping. The filter insert is available from your Authorised Service Centre or Customer Care.
4. Tighten the hose coupling a further half turn after seal contact.
5. Check that the connection does not leak.

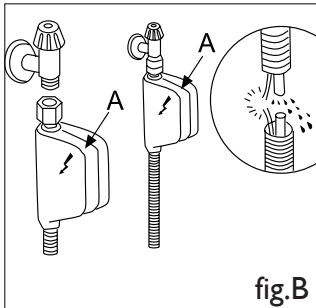

- ▶ Some models are fitted with an “Aquastop” water supply hose (see fig.B) in which the small filter is already housed in the threaded end.

Anti-Flooding protection

The dishwasher is equipped with a system that stops the supply of water in the event of a problem with the water supply hose, or leaks within the unit, in order to prevent damage to your home. If for any reason the box containing the electrical components happens to get damaged, turn off the power supply and remove the piug for the appliance from the socket immediately. In order to guarantee that the anti-flooding feature operates properly, the “A” box with water supply hose must be attached to the water supply tap as shown in fig.B. No other type of connection is acceptable. The water supply hose must not, under any circumstances, be cut, as it contains electrical parts which are live. If the length of the hose is not adequate to make a proper connection, the hose must be replaced with one which is long enough. This hose is available upon request from specialised rtailers and approved service center.

Installation

Drain Water Connection

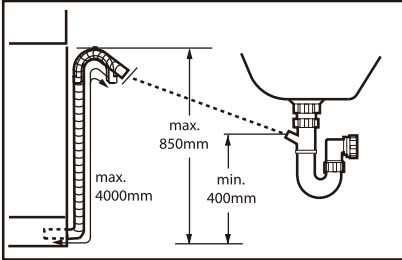

Fix the water drain hose properly to the piping. The hose has to reach at one point a height between 400 and 850 mm above the appliance bottom line!

An extension hose for the water drain hose must not exceed a total length of 4 m and must have the same diameter as the water drain hose.

Following connections are possible:

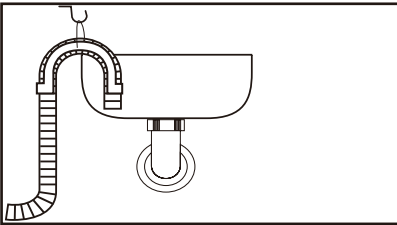

Drain hose to sink

- ▶ Hang the drain hose with the U-support over the edge of a sink with adequate size.
- ▶ Protect the U-support sufficiently against slipping.

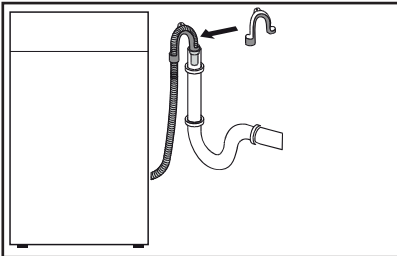

Drain hose to waste water connection

- ▶ The internal diameter of the stand pipe with vent-hole must be minimum 40 mm
- ▶ Put the drain hose for approx. 80 mm in the wastewater pipe.
- ▶ Attach the U-support and secure it sufficiently.

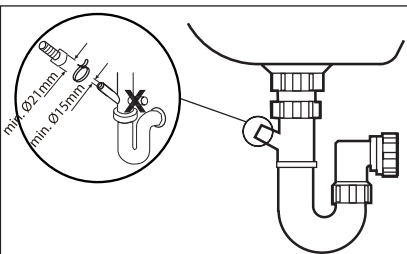

Drain hose to sink connection

- ▶ When connecting the drain hose to a sink trap with a drain hose spigot, make sure that the drain hose is supported to the height of the bench.
- ▶ Ensure the drain spigot has a minimum hole diameter of 15 mm and it has been drilled out.



CAUTION!

Ensure always that all connections (power supply, drain and fresh water hose) are firm, dry and leak free!

Take care these parts are never to be crushed, kinked, or twisted. If the supply cord is damaged, it must be replaced by the service agent (see warranty card) in order to avoid a hazard.

Technical Data

Check the electrical data on the rating label (located on the left-hand side of the dishwasher's stainless steel inner door). Should the data on the rating label be different to those specified below, consider those on the rating label as correct.

Suppliers name or trade mark	Haier			
Supplier's model identifier	HDW13G1	HDW14G2	HDW15G2P	HDW15G3
Rated capacity in standard -place settings	13	14	15	15
Mains water pressure	0.03-1 MPa (= 0.3-10 bar)			
Power voltage	230 V (50Hz)		220-240 V (50Hz)	
Maximum current intensity	10 A			
Total absorbed power	1900 W		1720-2050 W	
Colour				
White	HDW13G1W/HDW14G2W/HDW15G2PW/HDW15G3W			
Stainless Steel	HDW13G1X /HDW14G2X /HDW15G2PX /HDW15G3X			

Customer Service

We recommend our Haier Customer Service and the use of original spare parts.

If you have a problem with your appliance, please first check section TROUBLESHOOTING.

If you cannot find a solution there, please contact

- ▶ your local dealer or
- ▶ the Service & Support area at www.haier.com.au
or at www.haier.co.nz
where you can activate the service claim and also find FAQs.

To contact our Service, ensure that you have the following data available. The information can be found on the rating plate at the door.

Model _____

Serial No. _____

Standards Test

The dishwasher is tested to AS/NZS 2007 standards for both wash and dry performance using the parameters detailed below.

Wash programme	Eco When the programme is finished, open the door 100mm to help with drying
Powdered detergent quantities	5 g pre-wash + 26.25 g main wash
Rinse aid dosage level	dE (HDW13GI model)
Maximum number of place settings	13
Height adjustment of upper basket	Ensure the upper basket is in its lower most position

Recommended loading patterns

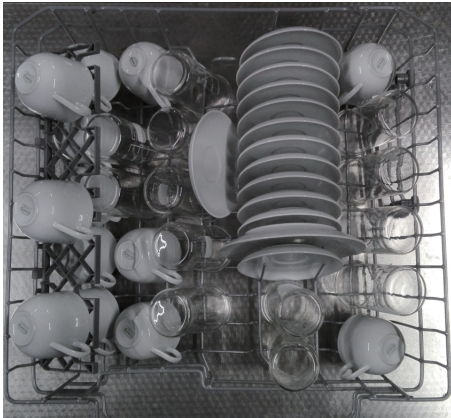

Upper basket

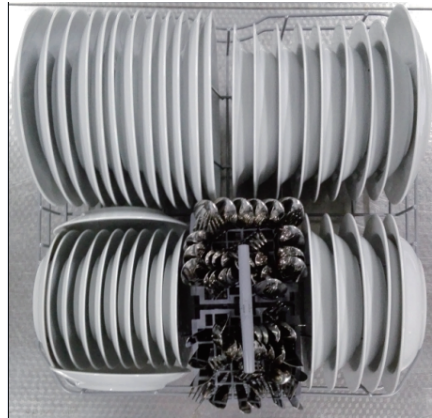

Lower basket

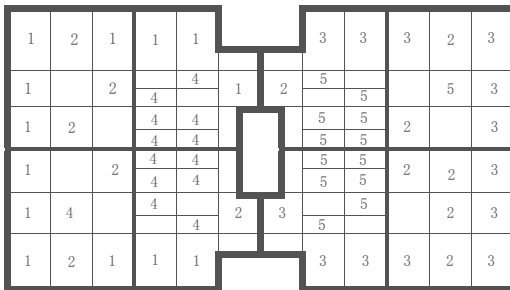

Cutlery basket

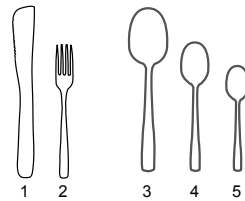

Standards Test

Wash programme	Eco When the programme is finished, open the door 100mm to help with drying
Powdered detergent quantities	5 g pre-wash + 27.5 g main wash
Rinse aid dosage level	dB (HDW14G2 model)
Maximum number of place settings	14
Height adjustment of upper basket	Ensure the upper basket is in its lower most position

Recommended loading patterns



Upper basket

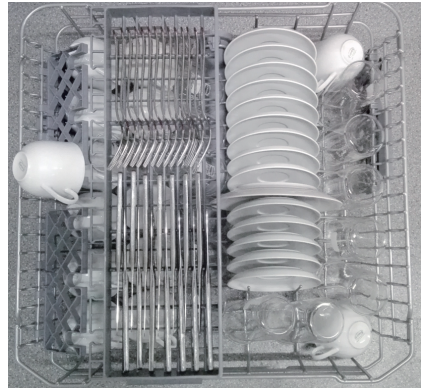

Upper basket with Utensil tray

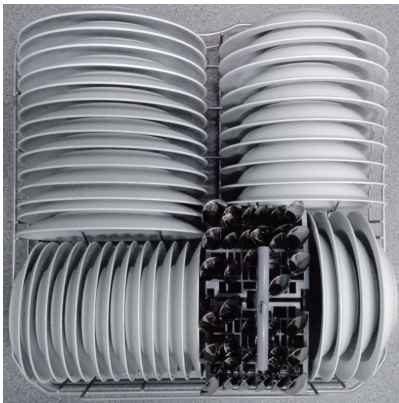

Lower basket

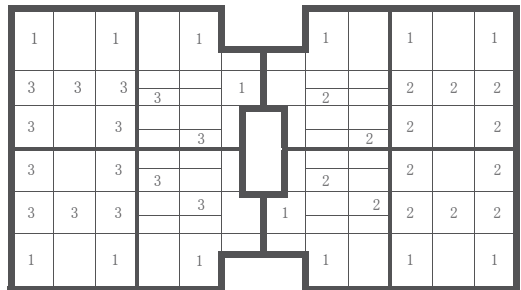

Cutlery basket

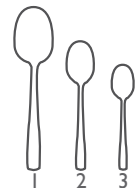

Standards Test

Wash programme	Eco When the programme is finished, open the door 100mm to help with drying
Powdered detergent quantities	5 g pre-wash + 28.75 g main wash
Rinse aid dosage level	dB (HDW15G2P / HDW15G3 models)
Maximum number of place settings	15
Height adjustment of upper basket	Ensure the upper basket is in its lower most position

Recommended loading patterns



Upper basket



Lower basket

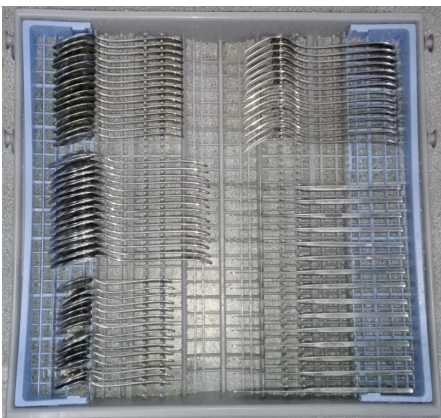

The third basket